

SPEKTRA

Ready for TESTelligence!

DT | Device Testing



Outstanding
**international
performance**

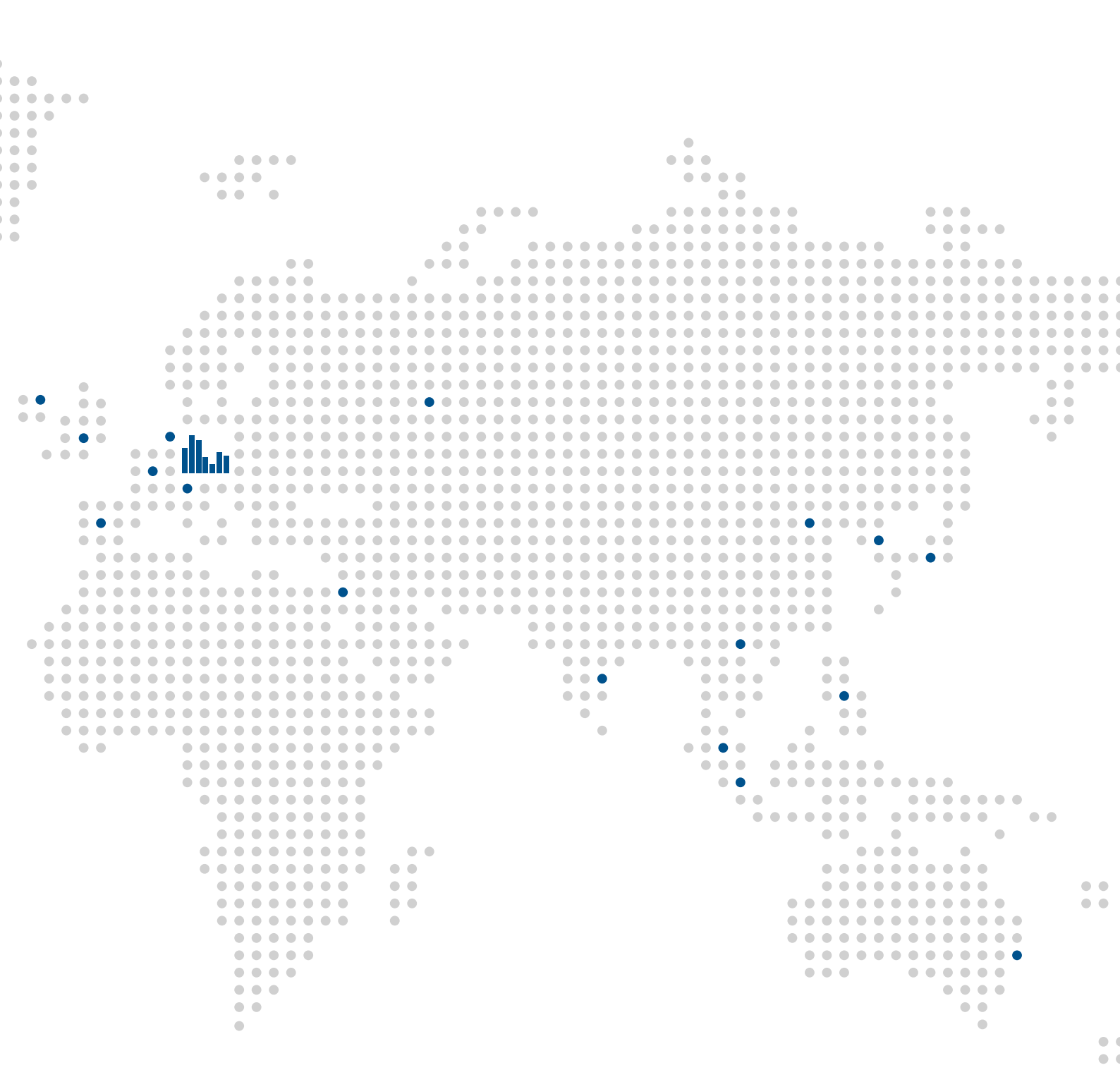

Who are we?

SPEKTRA Schwingungstechnik und Akustik GmbH Dresden, Germany was launched in 1994 by employees of the former state-owned company VEB Robotron Messelektronik Dresden, department of sound, vibration and force measurement. Up to 1989, this company was one of the leading manufacturers of measurement instrumentation for sound and vibration engineering worldwide. Based on decades

of experience in the field of „electrical measurement of mechanical quantities“, SPEKTRA has developed into a stable, mid-sized enterprise in the field of sound and vibration engineering. Advanced technologies and innovative ideas of our employees make SPEKTRA your premium partner for the development of measuring and testing systems as well as mechanical exciter for various applications.



CS | Calibration Solutions

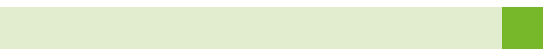

DT | Device Testing

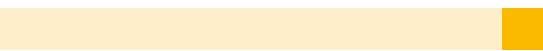

ST | Structural Testing

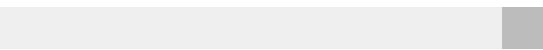

ES | Engineering Solutions

DT | Device Testing

Because of the company's experience with the development of precision calibration equipment, SPEKTRA is able to offer various test systems that simulate and stimulate nearly every type of dynamic measurement. SPEKTRA also offers test and calibration services as an alternative to test equipment ownership.

Our Portfolio

Competences

S-TEST System

- MEMS Sensor development and characterization
- Vibration Excitation - High Frequency
- Vibration Excitation - Medium Frequency
- Vibration Excitation - Low Frequency
- Piezoelectrical Excitation
- Shock Excitation
- Acoustic Excitation
- Pressure Excitation
- Temperature Sensitivity
- Magnetic Excitation
- Dynamic Rotation Excitation
- Electrical and Functional Testing
- Electrical Testing Accessories
- S-TEST System Concept
- How to find your optimum Device Testing Solution

Services

- Measurement Service - Device Characterization and Environmental Simulation
- Feasibility Studies
- Consulting

Professional Training

Selected References

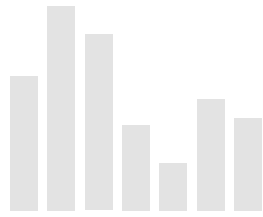

Ready for TESTelligence!

Our Portfolio

For the development and manufacture of quality products, precision tools are needed to ensure state-of-the-art performance. SPEKTRA offers premium solutions and services. Do you need equipment for tests in your laboratory or in your production facilities? SPEKTRA will find a solution for your measurement task. When no standardized device is available, we can offer customized test equipment to satisfy the need.

Device Types	Application	Stimulus
<ul style="list-style-type: none"> ✓ MEMS Type Sensors ✓ Accelerometers ✓ Gyroscopes ✓ Pressure Sensors ✓ Magnetic Field Sensors ✓ Force Sensors ✓ Sensor Systems / Clusters ✓ ECU Electronic Control Unit ✓ Other Electronic Components 	<ul style="list-style-type: none"> ✓ Mobile Navigation ✓ Driver Assistance Systems ✓ IoT - Internet of Things ✓ Medical Applications ✓ Virtual Reality ✓ IMU - Inertial Measurement Unit ✓ Airbag Sensors ✓ ABS / ESP ✓ Intelligent Force Bolt 	<ul style="list-style-type: none"> ✓ Dynamic Pressure ✓ Vibration ✓ Shock ✓ Temperature ✓ Rotation ✓ Magnetic Field ✓ Acoustics ✓ Dynamic Force ✓ Dynamic Acceleration

Competences

Turnkey Solutions for the Lab:

- ✓ Testing
- ✓ Characterization
- ✓ Calibration

Highly Parallel Subsystem for Production:

- ✓ Final Test / Component system level test
- ✓ Prototype production
- ✓ Volume production



- ✓ Effective for characterization in the lab
- ✓ Highly parallel in production

S-TEST System

MEMS Sensor development and characterization

If you want to perform a well-defined assessment of your products, very precise control of the mechanical stimulation is needed. Such controlled excitation is our specialty, driven by the development of calibration systems with a level of precision as required by national institutes for metrology.

We deliver systems with various stimuli that can work either as a stand-alone solution or in combination with different kinds of exciter, as required. If you already have an existing test platform, SPEKTRA's solution can be integrated with the existing equipment.

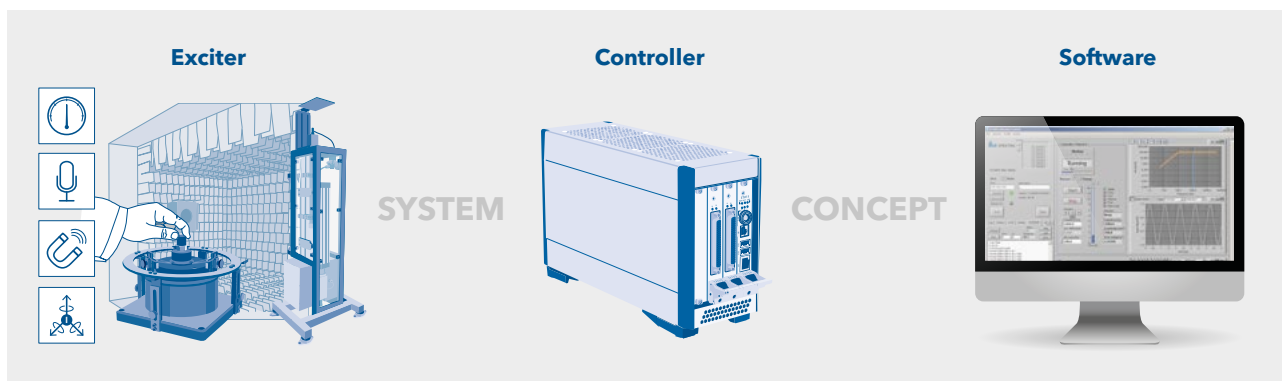

Exciter

Based on your sensor testing requirements you may choose from a wide range of different exciter. A combination of various exciter is also possible and we can even tailor solutions for very detailed sensor stimulus demands.

Test System

The S-TEST Lab system is designed for sensor development and characterization environments. Despite its compact size it still allows to test up to 4 sensors per tester board and supports all the main digital sensor interfaces of today's MEMS sensors.

Software

The S-Test software supports efficient testing of MEMS sensors in lab environments and in full production. The architecture fulfills the flexibility demands during sensor development and thus can reduce overall time-to-market.



Advantages

- ✓ Subsystem for automatic tests in production lines
- ✓ Mobile use in field
- ✓ Laboratory applications
- ✓ Combination of different unique exciters
- ✓ Easy integration into existing test environment
- ✓ Customized solutions for complex testing scenarios

Vibration Excitation - High Frequency

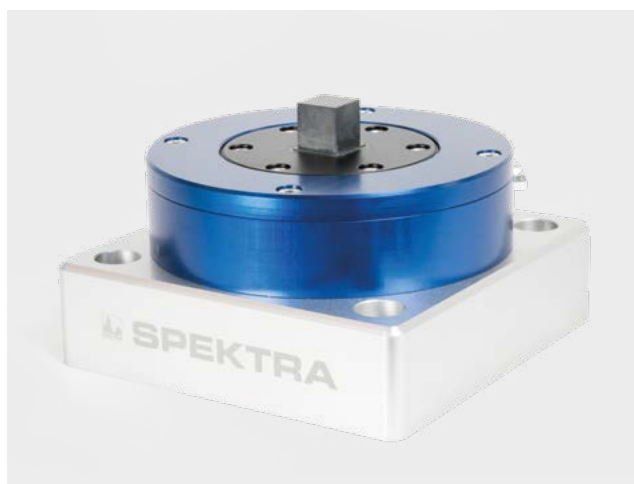

Features SE-16

- ✓ Vibration immunity test of MEMS sensors
- ✓ Development and test of MEMS sensors
- ✓ Armature allows mounting in different orientation to direction of movement
- ✓ Low transverse motion (< 10 %)
- ✓ Frequency range 5 kHz to 100 kHz (200 kHz)
- ✓ Force rating 100 N
- ✓ High acceleration amplitudes (up to 400 m/s²)

Driven by our calibration systems we can offer a huge spectrum of vibration exciter. They can be used for the characterization of sensors and vibration testing of any other devices. We can generate a precise sine excitation or nearly any other signal. So there is a solution available for any measurement task. The SE-16 is specially

designed for the high frequency excitation of MEMS Gyroscopes. The shaker provides a solution to test up to 200 kHz. Its armature made of technical ceramic gives the user the possibility to mount the device under test in multiple orientations. The armature can also be modified based on your requirements.

High-Frequency-Exciter

Model	SE-09	SE-11	SE-16
Illustration			
Frequency	5 Hz ... 50 kHz	1 kHz ... 50 kHz	5 kHz ... 100 kHz (200 kHz)
Acceleration	400 m/s ²	400 m/s ²	400 m/s ²
Direction of excitation	one direction (Diameter 50 mm)	Three directions, Armature Dimensions 30 mm x 30 mm	Three directions, Armature Dimensions 15 mm x 15 mm

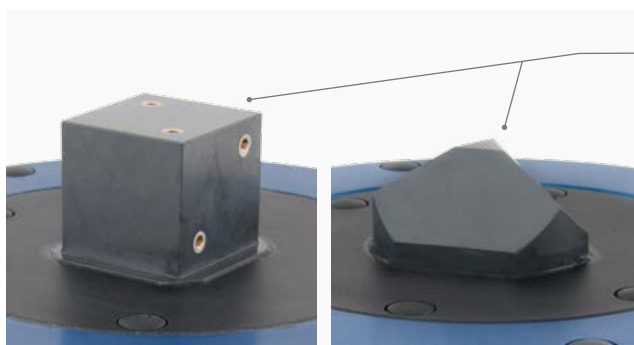

Spotlight



According to the characteristics of the device under test the mounting head of the SE-11 can be modified appropriate to your special test requirements. We even adjust the mounting head to help you fix your devices most efficiently, e.g. by drilling holes in the head to fit the screw holes of your DUT.

Vibration Excitation - Medium Frequency

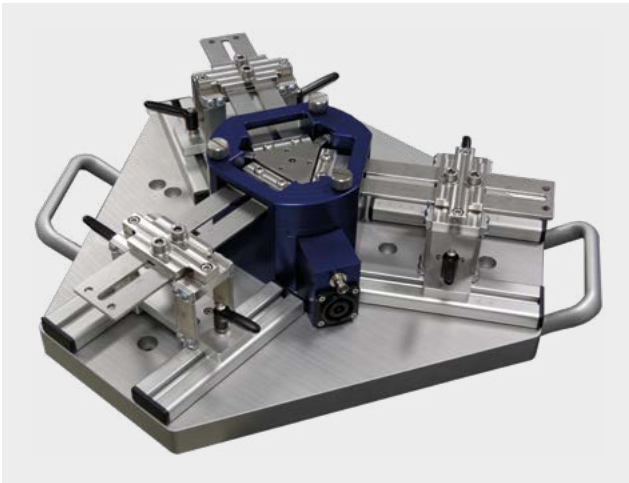

★ Features SE-101 RES-HA

- ✓ Very high acceleration amplitudes (up to 4.000 m/s²)
- ✓ Low transverse motions < 5 %
- ✓ Usable frequency range 65 Hz ... 500 Hz
- ✓ Maximum mass of DUT 300 gram
- ✓ Internal reference accelerometer (ICP® - type, sensitivity about 10 mV / g)
- ✓ Customized solutions and modifications on request

The main application for the SE-101 is the measurement of the amplitude linearity. Usually shakers are designed to perform a frequency dependent characterization and to calibrate accelerometers. Therefore the shaker cannot achieve high accelerations. If you want to measure the amplitude linearity you need to perform a shock excitation.

But since the variation of the shock amplitude causes a change of the pulse duration, the spectrum of the exciting pulse is changing. So there is also a frequency dependent component within the measurement. The SE-101 solves the issue regarding a frequency dependent excitation. It can excite your DUT up to 4.000 m/s² at a certain frequency.

Medium-Frequency-Exciter

Model	SE-10	SE-101 RES-HA	SE-14
Illustration			
Frequency	3 Hz ... 10 kHz	65 Hz ... 500 Hz	0 Hz ... 8 kHz
Acceleration	600 m/s ²	4.000 m/s ²	500 m/s ²
Payload	500 g	300 g	2 kg / 1 kg**

** vertical / horizontal (more payload on request)

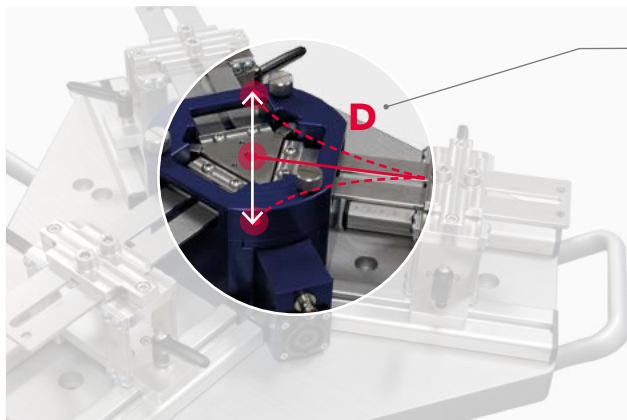

Spotlight

The SE-101 excites the DUT in the resonant frequency of the mass-spring system. The resonant frequency depends on the mass of the DUT and the length of the spring. The length of the spring can be modified to tune the resonant frequency. So you can adjust the resonator to characterize your DUT at a certain frequency with a high acceleration and a low power consumption.

Vibration Excitation - Low Frequency



Features SE-13





- ✓ 500 N force
- ✓ Frequency range: 0 Hz ... 400 Hz
- ✓ Unique frictionless support system carries up to 50 kg test load
- ✓ Efficient electrodynamic drive for sine, random or transient signals
- ✓ Very low cross motion according to ISO 16063-21
- ✓ Large mounting surface: Ø 350 mm

The SE-13 is an electromagnetic shaker. Due to its special air bearing, this shaker can generate a very precise sine vibration up to 400 Hz. This unique property gives you the opportunity to characterize your device under test in a very low frequency range. If a higher acceleration amplitude at very low

frequencies below 1 Hz is required the APS long-stroke shakers offer a maximum stroke of up to 450 mm. These shakers are available with an air-bearing design for very precise motion with low noise and with a robust ball bearing design for harsh testing conditions.

Low-Frequency-Exciter

AIR BEARING	APS 600	APS 113-AB	APS 129	APS 500	SE-13
Illustration					
Frequency	0 Hz ... 100 Hz	0 Hz ... 200 Hz	0 Hz ... 200 Hz	0 Hz ... 200 Hz	0 Hz ... 400 Hz
Stroke*	450 mm	158 mm	158 mm	152 mm	25 mm
Payload*	25 kg	1,5 kg	23 kg	3 kg	50 kg
Force*	200 N	186 N	186 N	95 N	500 N

BALL BEARING	APS 113	APS 400	APS 420
Illustration			
Frequency	0 Hz ... 200 Hz	0 Hz ... 200 Hz	0 Hz ... 200 Hz
Stroke*	158 mm	158 mm	150 mm
Payload*	23 kg	30 kg	35 kg
Force*	186 N	445 N	900 N

* Maximum

Piezoelectrical Excitation



★ Features PATENT PENDING

- ✓ High Frequency excitation of big & heavy DUT (e.g. sensor cluster with gyroscopes)
- ✓ Cube from technical ceramics with piezo-electric drive
- ✓ Low weight and high stiffness lead to high resonance frequency
- ✓ Vibration vs. temperature test in thermal chamber possible

The Piezocube is a very special exciter. There is no electromagnetic drive, as is typical for most exciter. A piezo actuator is used to introduce a vibration into a cube. Nearly any vibration profile can be generated in your device under test using this tech-

nology, including very high frequencies. Its special design allows you to introduce vibrations at different attachment points of your device under test, which easily facilitates a controlled modal analysis, e.g. of a control unit in the automotive industry.

Piezoelectrical Exciter

Model	PC - 01	PC - X
Illustration		
Degrees of freedom	Single Axis	Multi Axis
Frequency	5 kHz ... 40 kHz	5 kHz ... 40 kHz

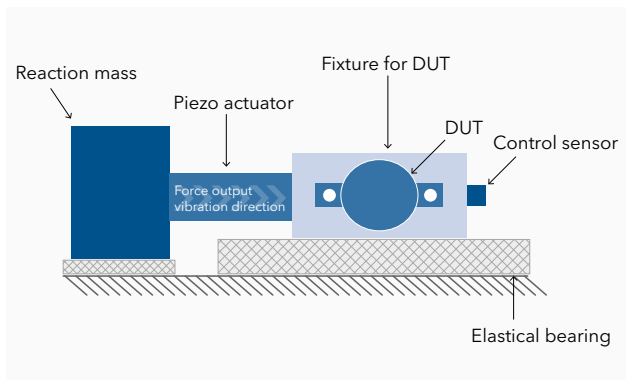

Spotlight

The **Piezocube** is not driven by an electromagnetic drive. A piezo actuator moves a reaction mass with respect to the device under test. As a result we can introduce vibrations in a very high frequency range.

Shock Excitation



Features



- ✓ Broad amplitude range from 200 m/s² ... 2.000 km/s²
- ✓ Type of excitation: sinusoidal shock, adjustable signal shape or burst
- ✓ Excitation by hammer-anvil or piezoelectric actuator
- ✓ Independent control of amplitude & pulse width (within certain ranges, see table)
- ✓ Excellent repeatability of shock

If you need a shock excitation far beyond the capabilities of standardized vibration systems, we have a solution for you. Our shock exciter can apply accelerations up to 2.000 km/s². To optimize the test time

our shock systems are fully automated test systems. Depending on your application they might also be customized for you. The exciter can be based on the Hopkinson principle or the hammer-anvil principle.

Shock-Exciter

Model	SE-222 HOP-VHS	SE-221 HOP-HS	SE- 220 HOP-MS	SE-201 PN-LMS	
Illustration					
Acceleration	100 km/s ² ... 2.000 km/s ²	100 km/s ² ... 1.000 km/s ²	200 m/s ² ... 40 km/s ²	2 km/s ² ... 100 km/s ²	50 m/s ² ... 2,5 km/s ²
Payload*	15 g	30 g	30 g	80 g	80 g
Pulse Width* (half sine)	20 μs	25 μs	40 μs ... 180 μs	0,1 ms ... 0,5 ms	2 ms ... 5 ms

* Maximum

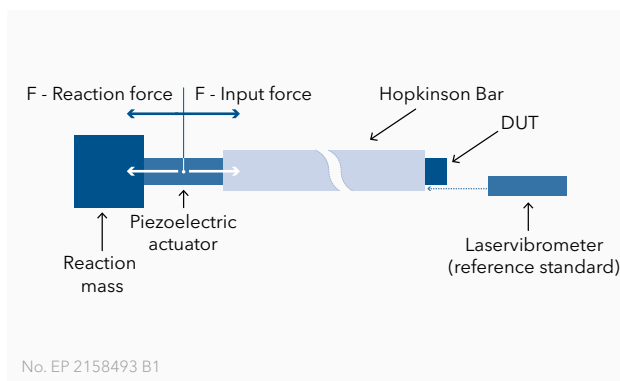

Spotlight



The operation principle is the **shock excitation** of a long and slender metal bar with a piezo actuator and the generation of a longitudinal wave inside of the bar. Due to excitation with a piezo actuator a very precise and controlled pulse can be introduced into the bar. So you can adjust the pulse length and amplitude completely independently.

Acoustic Excitation

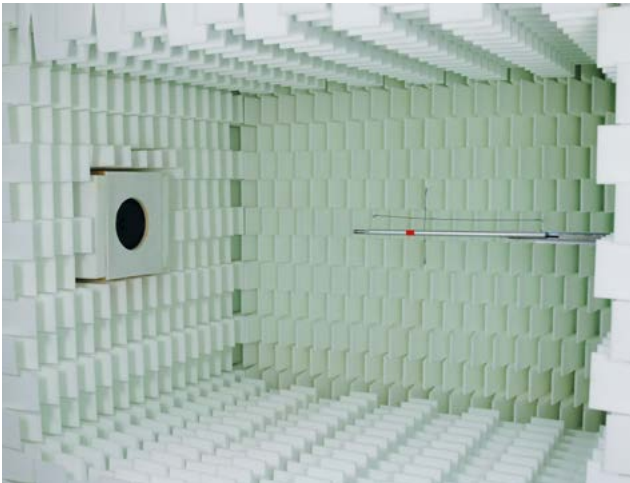

★ Features Acoustic Chamber

- ✓ Test of MEMS microphones
- ✓ High sound pressure excitation of MEMS gyroscopes
- ✓ Test under free-field & pressure chamber conditions
- ✓ Frequency range: 0,1 Hz ... 20 kHz

The excitation with an acoustical system is not only interesting for the characterization and calibration of microphones. A controlled sound wave can also be used for the excitation of sensors and structures. For instance, you can use the acoustical excitation for the resonance search and perform a modal analysis. Another possibility is the impact of background noise on the characteristics of a sensor.

The major advantage of using an acoustical excitation is the direction independent excitation. If you use a shaker, there is always only one direction being excited. We can offer to do a controlled acoustical excitation of structures and sensors. Also the acoustical control system can be used for the very precise characterization of microphones, e.g. the final test of microphones.

Acoustic Exciter

Model	SQ-101	SQ-03	SQ-4.1	SQ-4.2
Illustration				
Frequency	125 Hz ... 20 kHz	0,1 Hz ... 31,5 Hz	31,5 Hz ... 8 kHz	31,5 Hz ... 16 kHz
Sound Pressure	74 dB ... 94 dB	114 dB ... 124 dB	64 dB ... 124 dB	64 dB ... 124 dB

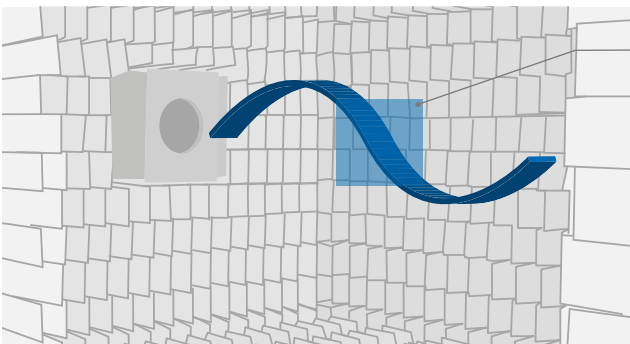

Spotlight



The size of the room with real free-field conditions depends on the desired frequency range and the size of the **anechoic chamber**. We can realize different dimensions for adjusting the size of the free-field and the required frequency range.

Pressure Excitation





Features DPE-02

- ✓ Dynamic pressure excitation for characterization and calibration
- ✓ Pulse duration below 2 ms
- ✓ Performing fully automated test sequences
- ✓ Usable as vibration shock exciter

For characterization and testing of pressure sensors, we offer a unique test device that provides both sine and shock excitation. The DPE-02 is an exciter that can introduce a pressure pulse into your sensor. The maximum pressure level that can be achieved is 420 MPa. To integrate the different kinds of devices under test, we offer an adaptation of the

pressure chamber as necessary, e.g. the sealing between the pressure chamber and the sensor can be modified based on your requirements. Depending on the sensor, the pressure gradient can also be scaled to a suitable level. The DPE-02 can be configured for use as a vibration shock exciter.

Pressure Exciter

Model	DPE-01	DPE-02
Illustration		
Frequency	10 Hz ... 2 kHz	-
Pulse Width	-	< 2 ms
Amplitude	100 Pa ... 16 kPa	22 MPa ... 420 MPa

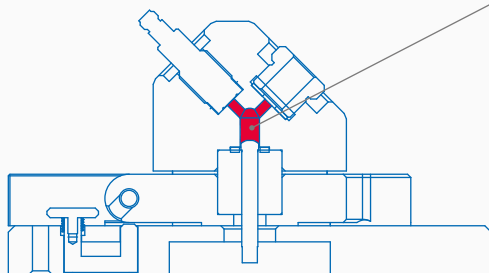

Spotlight



The DPE-02 generates a dynamic pressure pulse. The main chamber is filled with oil and is compressed by a projectile. This compression creates a short pressure pulse. Since the DUT and the reference sensor are mounted on the same level you can easily monitor and control the pressure applied to them.

Temperature Sensitivity

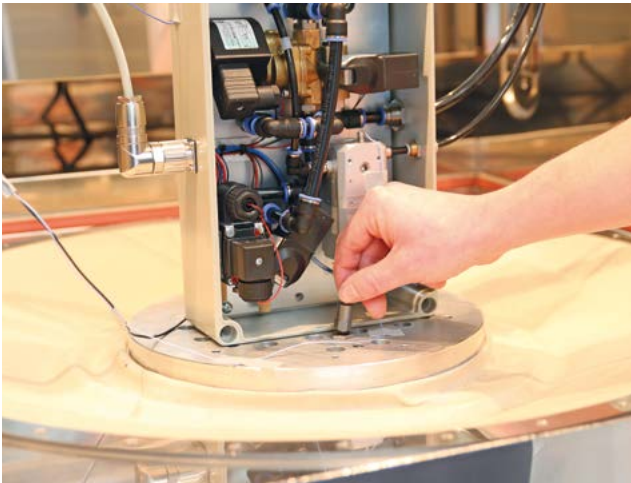

★ Features

- ✓ Combination of different kinds of excitation with temperature excitation, e.g. vibration and magnetic field
- ✓ Huge spectrum of different types of exciter for very precise temperature control or high-speed temperature change

In the application of sensors and other devices there is not only one excitation (e. g. vibration) present. You always characterize your device under test at a certain temperature. But usually every final customer will have his individual conditions. As a consequence to improve the quality of your products, the temperature depen-

dency should be characterized. You can test the cross talk between temperature and vibration excitation or the impact of the temperature to the magnetic sensitivity. For the temperature control you can choose between different types of exciter: Peltier thermal chamber, climatic chamber or ThermoStream®.

Temperature Test Methods

Method	Peltier element	Climatic chamber	ThermoStream®
Highlight	Very accurate temperature control due to thermoelectric Peltier effect	Wide temperature range Test of multiple samples	High temperature gradient
Temperature range	-10 °C ... 70 °C	-70 °C ... 180 °C	-80 °C ... 225 °C
Velocity of temperature change	Slow (4 K/min)	Medium (10 K/min)	Very high (~ 2.000 K/min)



Spotlight



We can combine several types of stimuli as vibration or magnetic excitation with the temperature control. For the complete test setup there will be a single controller to ensure defined test conditions for your application.

Magnetic Excitation

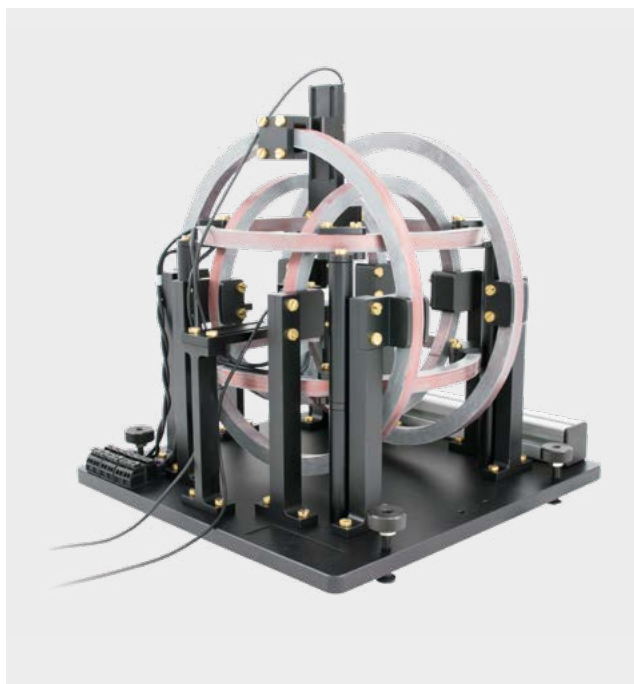

★ Features FDG-15

- ✓ Generation of 3 dimensional AC/DC magnetic fields for MEMS characterization and EMC tests of small components using Helmholtz Coil Systems
- ✓ Frequency range: up to 150 kHz
- ✓ Flux density up to 10 mT
- ✓ Arbitrary orientation (space, time) of main field vector
- ✓ Size of homogeneous field (0,5 % tolerance): up to 40 mm x 40 mm x 40 mm
- ✓ Combination with thermal testing, vibration and angular rate possible
- ✓ 3 x double Helmholtz Coils for high homogeneous magnetic fields available

Our magnet unit is designed to provide a very precise three-dimensional magnetic field for your DUT. A constant or oscillating magnetic field can be generated in any desired direction in space. The frequency can go up to 150 kHz. You can also combine the magnetic excitation with different mea-

asures, e.g. temperature, vibration or angular rate. Mostly customized solutions are necessary to reach the targeted parameters (flux density, frequency, size and quality of homogeneous field). Our engineers will support you with simulations and design studies to get the best performance for your individual task.

Dynamic Rotation Excitation



★ Features DRE-01

- ✓ Based on a galvanometer
- ✓ Frequency range 1 Hz ... 5 kHz
- ✓ Very low cross-acceleration
- ✓ Max. Payload 100 g
- ✓ Max. angular velocity: 3500 °/s
- ✓ Max. angular acceleration: $2.5 \cdot 10^6$ °/s²
- ✓ Distortion factor (angular velocity): < 3%

Driven by our customers we always aim for new types of dynamic stimuli to fulfill your requirements. Many of our products go back to such cooperations. If you have any measurement task please contact us.



Telephone: +49 351 400 24 0
Email: sales@spektra-dresden.com





Electrical and Functional Testing



★ Features Electrical Testing

- ✓ Electrical and functional characterization of new devices
- ✓ Verification of datasheet information
- ✓ Development of test procedures for volume production
- ✓ Analysis of field returns
- ✓ Debugging of sensor design flaws

S-TEST System Configurations

System	Lab Systems		Fab Systems	
Model	S-TEST - 2	S-TEST - 16	S-TEST - 48	S-TEST - 192
Illustration				
No. of UTB	2	16	48	192
Interface	Ethernet	Ethernet	Ethernet	Ethernet
Cooling	Integrated	Integrated	Modular	Modular

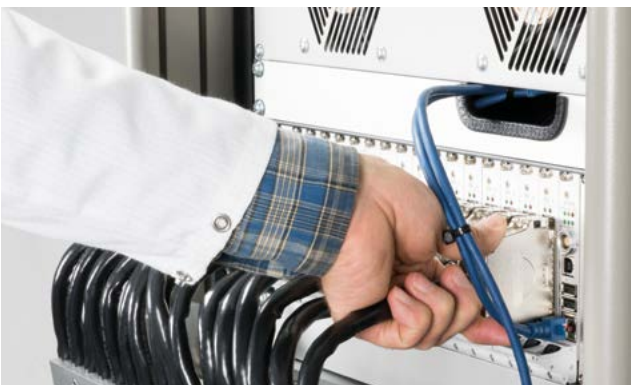

Spotlight 🔍

The S-TEST system is scalable to allow testing of a small number of devices in sensor development environments up hundreds of devices during cost-efficient **system level testing (SLT)** in full production. Test engineers can prepare final production tests already in the lab by using the same test system.

Electrical Testing Accessories

Engineering Board

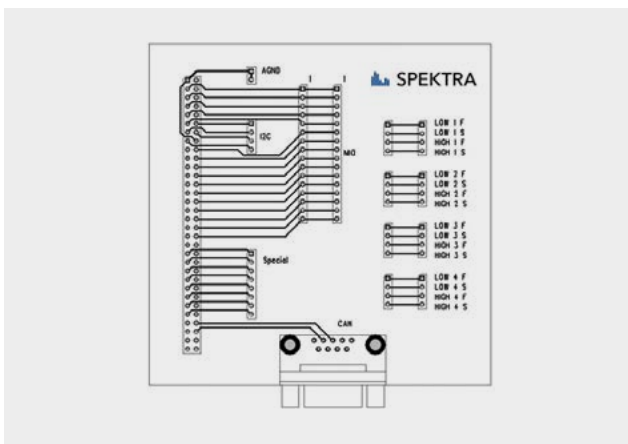

★ Features

- ✓ Perfect learning tool
- ✓ Selected components for the first steps
- ✓ Training Course
- ✓ **Components:** I²C EEPROM, Oscillator, NTC-Resistor, Zener-Diode, Triaxial sensor with SPI and I²C
- ✓ **Wiring:** Routed directly on PCB, Selection of components by using jumper blocks

Evaluation Board

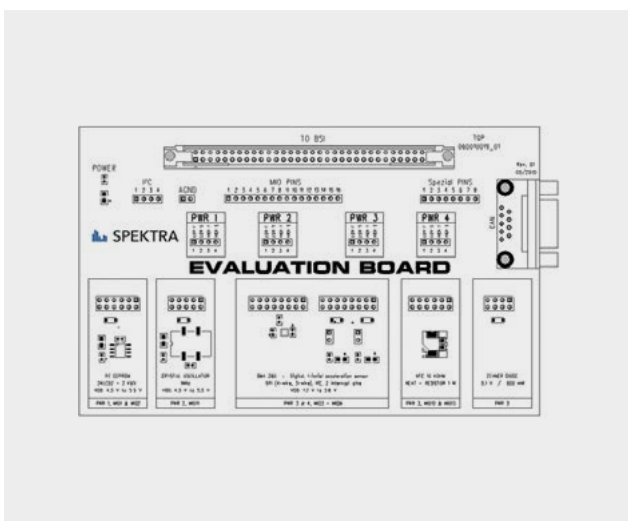

★ Features

- ✓ Perfect learning tool
- ✓ Selected components for the first steps
- ✓ Development of customized adapter boards
- ✓ Training Course
- ✓ **Connectors:** CAN Sub-D, multiple connectors
- ✓ **Wiring:** Connectors routed directly on PCB, connection of DUT by adapter boards or open-end-wires

Customized Adapter Box



★ Features

- ✓ Perfect engineering tool
- ✓ Fully customized
- ✓ **Connectors:** According to customers requirements
- ✓ **Wiring:** Routed directly on PCB, connection of DUT e.g. by receptacles

S-TEST System Concept



Universal Tester Board (UTB)

UTB, developed especially for development and final testing purposes upto 4 DUT can be connected to one card, so an optimum cost-to-benefit ratio is ensured.

System Configuration

The different system configurations allow flexible adaptation to almost every test capacity requirement. UTB cards can be added to the maximum possible per chassis and several single systems can be combined and stacked for volume production.

S-TEST Software

The SPEKTRA programming environment ensures optimum support of preparing the test programs and managing higher numbers of channels.

Universal Tester Board

The Universal Tester Board represents the core element of the S-TEST system. Its numerous hardware resources and technical features allow the flexible use as main platform for the **system level testing** of modern sensor devices.



DMM

- ✓ **Differential Input** Channel
- ✓ **Matrix Multiplexer** for up to 16 analog input channels

Time Measurement Unit

- ✓ **Time resolution** down to **12.5 ns**
- ✓ Comparator with **adjustable thresholds**

Power / Measurement

- ✓ **4 V/Is** (analog sources)
- ✓ **-2 ... 20 V DC**
- ✓ **200 µA / 2 mA / 50 mA**

Multi I/O

- ✓ **16 I/O** (analog or digital)
- ✓ Data rate up to **20 MHz**
- ✓ Output: **-2 ... 6 V**
- ✓ Input: **-2 ... 25 V**

FPGA

- ✓ **LVDS** communication
- ✓ **NIOS** softcore processor
- ✓ **Digital Sensor Interfaces** as **IP-Core:** SPI, I²C, CAN, JTAG, PS15, LIN, SENT, ZACwire

System Configuration



Features

- ✓ Standard communication interface to control and configure the system
- ✓ Different Models to meet diverse capacity requirements
- ✓ Scalable by easy addition of more UTB's
- ✓ Desktop versions for lab use
- ✓ Rack versions for fab installation

System communication interface

Independent of the actually used number of UTB's in a given configuration every system is accessible via the always included Communication Controller Board. It is the main communication interface of the S-TEST system. It enables network integration and remote access to the S-TEST platform and offers functions like system and test configuration, FW Upgrade, Chassis Self-Calibration and of course network storage of test results.



Communication

- ✓ **Gigabit LAN**
- ✓ **3 x USB** for Configuration and Maintenance
- ✓ **DDS-module** for clock generation e.g. for SPI
- ✓ **36 LVDS Lines** for internal Tester Board communication

Digital Front-End

- ✓ **2 x Trigger Input**
- ✓ **2 x Digital Output**
- ✓ **5 V Supply Voltage**
- ✓ **Calibration Lines** for Voltage and Resistance

Chassis Self Calibration

- ✓ Highly stable **reference voltage source**
- ✓ **Precision reference resistors**

Implementation of Digital Communication

In SPEKTRA MEMS Testers, digital communication is implemented by the IP cores in the FPGA of the UTB. In contrast to pattern-based approaches, this implementation ensures very high comfort in using the digital interface.

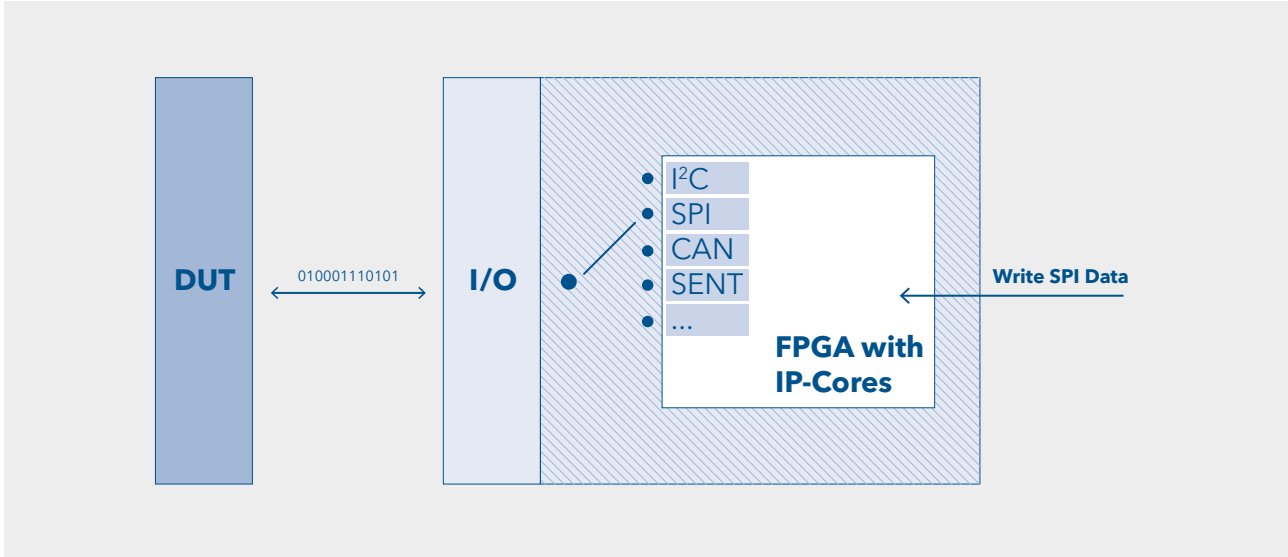

Digital communication in FPGA

Flexibility in Communication Protocols

- ✓ IP-Cores are developed by SPEKTRA or
- ✓ IP-Cores are purchased from 3rd parties as „open source system“
- ✓ Current implementation: SPI, I²C, I²C@18V, CAN, JTAG, PS15, SENT, LIN, ZACWire
- ✓ Function of IP-Cores can be modified - high flexibility
- ✓ Convenient usage of digital communication

Service and Maintenance

- ✓ Typical uptime > 99 %
- ✓ Low-maintenance tester configuration
- ✓ Multi-stage calibration concept for minimizing downtimes
- ✓ On-site calibration by SPEKTRA on demand
- ✓ Calibration via by user feasible optional calibration set
- ✓ Professional training courses about programming, maintenance and service on demand

Version 1 - Sequence of test operations controlled by PC

- ✓ Host PC transmits commands to Communication Controller Board (CCB) via drivers
- ✓ CCB interprets commands and transmits interface data to the respective active interface on the UTB
- ✓ Interface transmits response data to CCB
- ✓ CCB transmits results to Host PC
- ✓ Commands are transmitted by driver in an asynchronous matter to the host via CCB and UTB
- ✓ Communication is performed at high speed due to queuing of commands



Benefits

- ✓ Test routine runs completely on Host PC
- ✓ Easy debugging
- ✓ Test routine and communication by driver are executed mainly in parallel by multi-threading

Drawbacks

- ✓ Long communication paths via drivers, interface computer and backplane restrict the data rate

Version 2 - Test routine with execution of test steps by means of NIOS Microcontroller on UTB

- ✓ Host loads test routine to UTB
- ✓ Host initializes test as in version 1
- ✓ Host starts executing the test sequence
- ✓ Test sequence is processed within UTB under real-time conditions
- ✓ Full speed can be maintained also in continuous operation
- ✓ Free programming of how to preprocess measurement and test results on UTB
- ✓ Test sequence returns preprocessed results
- ✓ Host interprets results



Benefits

- ✓ Test routine runs completely / in parts on NIOS microcontroller
- ✓ Very little communication via drivers, CCB and backplane
- ✓ Very high data rate achievable between device under test (DUT) and UTB
- ✓ Massive reduction of test pages

Drawbacks

- ✓ Possible limitation of computationally intensive functions by the architecture of the NIOS microcontroller

S-TEST Software

The S-TEST software provides a versatile and flexible architecture and the different software layers expose efficient API's to support every user type. Time-critical test functionality can be implemented very close to the hardware and runs directly inside the performant NIOS II soft processor, the Device Driver Layer

er provides an abstraction of additional hardware components or interfaces, the Script Layer offers an easy method to create and expand test flow descriptions and the technology-agnostic GUI layer can be adjusted to support multiple usage scenarios like visual test control.

★ Your benefits

- ✓ Reduced programming effort
- ✓ Full offline functionality
- ✓ Guided system configuration
- ✓ Parallelization
- ✓ Program code generation
- ✓ Automatic logging
- ✓ Configuration of project variations

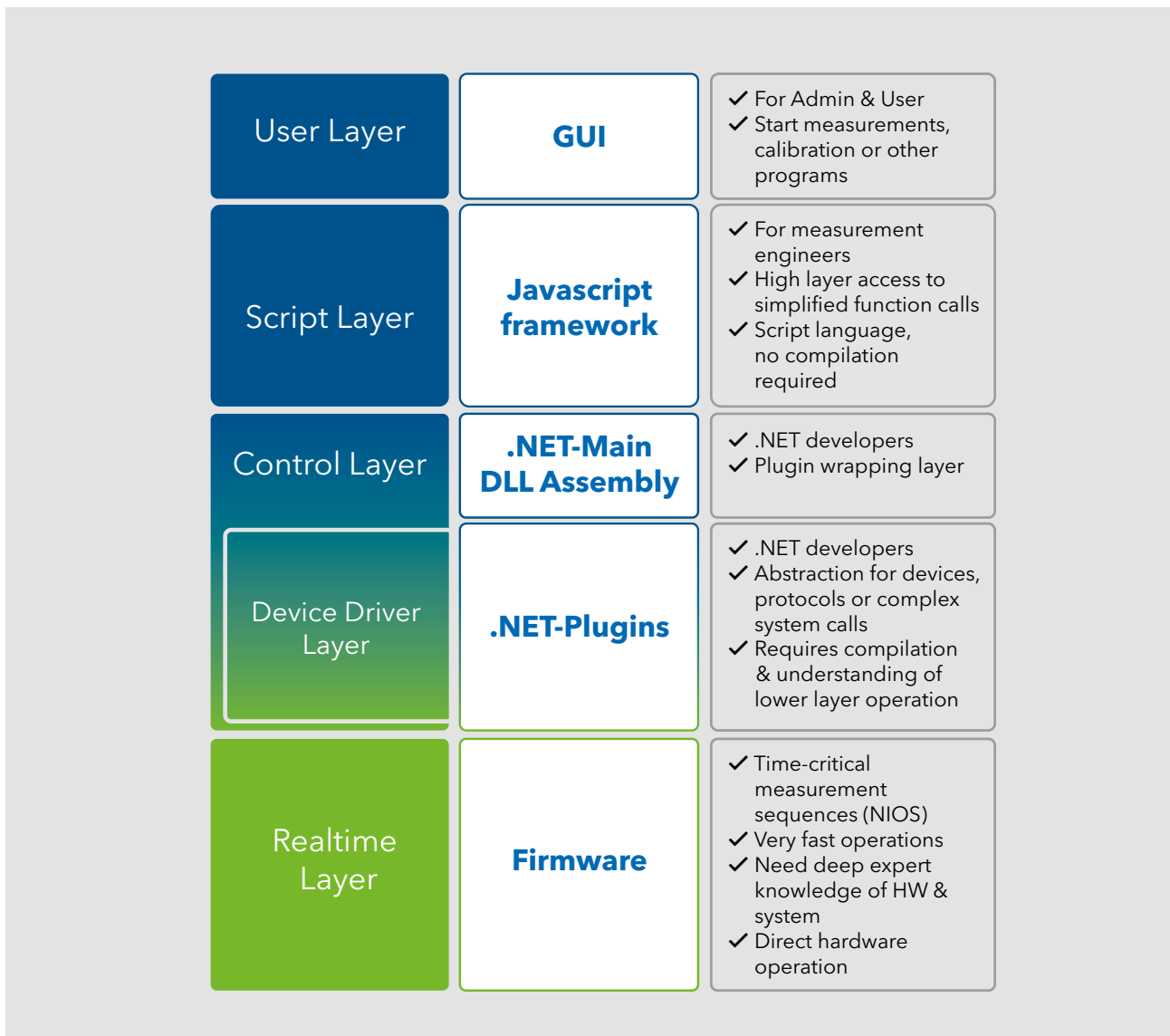

Sensor Test Project Flow

The S-TEST system concept is relying on several prerequisites. The DUT's are supposed to be already functional sensor devices that expose an operational electrical and logical test interface. The device test specification defines the required resources that the UTB has to provide and which interface standard the test should use. Then the electrical connections between UTB I/O pins and the DUT have to be

mapped inside the S-TEST software. Time-critical test steps have to be implemented as low layer NIOS test sequence while others can be implemented by means of the versatile TCP command set. Test programs that have been developed by sensor developers or test engineers can later be deployed into the parallel **system level testing** process during manufacturing.



How to find your optimum Device Testing Solution

All Device Testing Solutions are flexible to a certain degree and can therefore easily be adapted to the customer's requirements. For instance, one system may include several vibration exciter for the purpose of covering a wider frequency range.

Some of our different exciter can be combined in one system as well. Ask us for your customized solution.

Shortcut to finding your solution!

Link to our Website

Typical Solutions

For a first orientation the following table shows a few examples of device testing systems tailored to typical customer applications.

Vibration Control System for high frequency excitation	Vibration Control System including Piezocube	Shock Control System for low - medium shock excitation
<ul style="list-style-type: none"> ✓ Application: High frequency excitation of DUT, e.g. for characterization of MEMS sensors ✓ Frequency range: 1 kHz ... 95 kHz ✓ Acceleration amplitude: up to 400 m/s² ✓ Real time data acquisition and close-loop control 	<ul style="list-style-type: none"> ✓ Excitation of DUT with Piezocube ✓ Application: HF characterization of big devices (sensor cluster) ✓ Vibration under temperature test in thermal chamber ✓ Frequency range: 5 kHz ... 40 kHz ✓ Acceleration amplitude: up to 300 m/s² ✓ Real time data acquisition and close-loop control 	<ul style="list-style-type: none"> ✓ Acceleration amplitudes from 50 m/s² to 100 km/s² ✓ Pulse durations from 0,1 ms ... 1 ms ✓ Working principles: pneumatically driven hammer-anvil-principle ✓ Fully automated test system ✓ Sensor masses up to 80 gram (depending on reference sensor)

Acoustic Control System in free-field conditions	Magnetic Control System	Pressure Control System
<ul style="list-style-type: none"> ✓ Test of MEMS microphones ✓ High sound pressure excitation of MEMS gyroscopes ✓ Frequency range: 125 Hz ... 20 kHz ✓ Sound pressure up to 94 dB ✓ True free-field and pressure chamber 	<ul style="list-style-type: none"> ✓ Flux density: 2 mT ✓ Size of homogeneous field (0.5 % tolerance): up to 40 mm x 40 mm x 40 mm ✓ Arbitrary orientation (space, time) of main field vector 	<ul style="list-style-type: none"> ✓ Excitation of pressure sensors ✓ Automated test procedure ✓ Pressure range: 22 MPa ... 420 MPa ✓ Pulse width: < 2 ms ✓ Pulse shape: half-sine

**Please contact us for solutions with regard to your range of application.
We look forward to answering your questions.**



Telephone: +49 351 400 24 0
Fax: +49 351 400 24 99
Email: sales@spektra-dresden.com
Web: www.spektra-dresden.com



S-TEST Services

Measurement Service - Device Characterization and Environmental Simulation

A wide variety of SPEKTRA Test and Characterization Systems are available in our measurement and test laboratory for performing measurements and investigations of all kinds. Take advantage of the competence of our staff and the flexible availability of our wide range of Device Testing Systems and use them for solving your test jobs.

Our Performance Spectrum

- ✓ Device excitation with various stimuli (vibration, shock, pressure, sound)
- ✓ Device sensitivity tests (temperature, magnetic field)
- ✓ Combined measurement of various stimuli (e.g. temperature-vibration, temperature-magnetic-field, ...)

Feasibility Studies

You need to solve a test job but you do not have any appropriate test method or test instrumentation at hand? So do employ the know-how of our engineers to specify your demands based on theoretical and practical investigations / studies.

- ✓ Feasibility studies based on well-defined test specifications
- ✓ Theoretical as well as practical investigations into the effects of influence variables on your device under test
- ✓ Competent advice in all questions of sound and vibration engineering

Consulting

Modern measurement instrumentation is getting smaller and smaller, more and more compact, and more and more efficient in performance. However, its use may cause problems that are more and more complex, and possible remedies are becoming less and less transparent. If you are faced with problems that you and your associates are unable to solve, keep us in mind, perhaps we can help you. SPEKTRA, with our many years of experience in measurement technology, may be able to solve your measuring task / problems or provide advice on how to tackle your problems.



Professional Training

Would you like to optimize your business processes and make your business even more successful? Tap into your full potential - with customized SPEKTRA trainings. Whether as an employee in the calibration laboratory, part of a project team or product users, our training courses will prepare you better for your job. Well-grounded, compact and precisely matching your industry and goals.

Training I - S-TEST Lab Application Seminar

- ✓ Vibration Control System (VCS)
- ✓ Sine excitation up to 4.000 m/s² using the SPEKTRA Resonator SE-101
- ✓ High frequency and three-dimensional excitation

Training II - S-TEST Fab User Seminar

- ✓ S-TEST-Seminar for application / development
- ✓ S-TEST-Seminar for calibration
- ✓ S-TEST-Seminar for service / maintenance

Training III - Customized user seminars on request

All offered seminars are also available as individual trainings at customer's site. We would be happy to adapt the content according to your specific needs or assist you in finding the right solution for your demands. Please contact us:



Telephone: +49 351 400 24 0
Email: sales@spektra-dresden.com

Details, participation requirements, duration and price of the seminars can be found in our detailed training catalog.

Selected References

SPEKTRA Schwingungstechnik und Akustik GmbH Dresden is globally well-positioned. Together with our representatives, we serve a wide variety of customers worldwide with very individual requirements. Among our customers are manufacturers and suppliers for the automotive and rail industry, consumer electronics, electronic components, sensors and other industries:

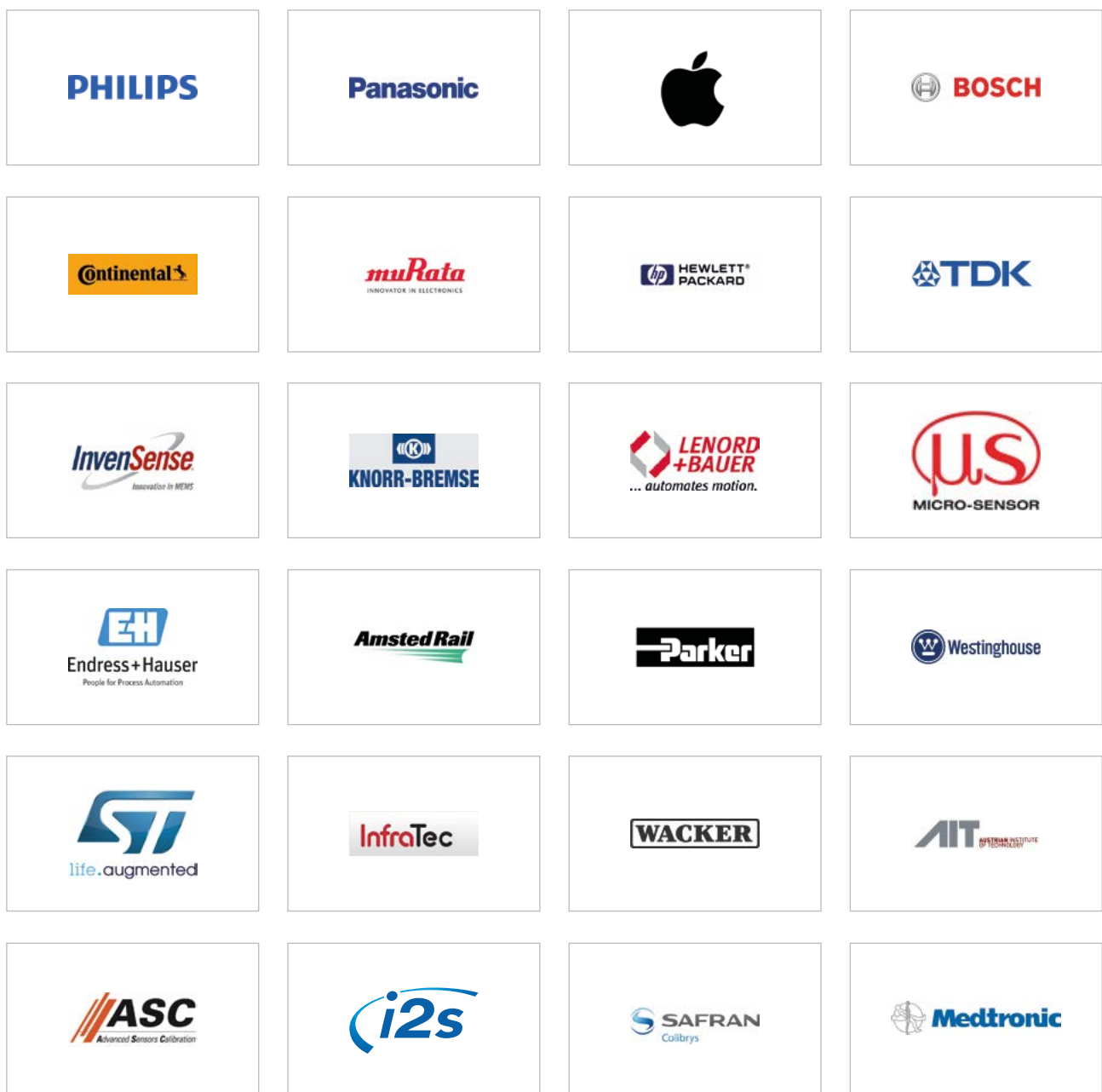

Contact us

Headquarters

**SPEKTRA Schwingungstechnik und
Akustik GmbH Dresden**

Heidelberger Str. 12
DE - 01189 Dresden



Telephone: +49 351 400 24 0
Fax: +49 351 400 24 99
Email: sales@spektra-dresden.com
Web: www.spektra-dresden.com

Managing Directors: Dr. Holger Nicklich, Martin Nicklich
Commercial register: Amtsgericht Dresden, HRB 10328
VAT-ID: DE 166 333 013

US Office

APS Dynamics, Inc.

32124 Paseo Adelanto, Suite 3
San Juan Capistrano, CA 92675



Telephone: +1-949-234-9791
Fax: +1-760-683-3184
Email: sales@spektra-usa.com
Web: www.spektra-usa.com

